









TERAFEST DECKING ACCESSORIES

AL-SMART SYSTEM





JOISTS

			
Product	AL-SMART joist 25	AL-SMART joist 40	AL-SMART joist 75
Dimensions	35 × 25 mm	40 × 40 mm	40 × 75 mm
Length	4 m	4 m	4 m
Material	aluminium	aluminium	aluminium
Underlying	400 mm	600 mm	1000 mm



CLIPS

				
Product	AL-SMART STANDARD CLIP	AL-SMART START CLIP 7 mm	AL-SMART CLIP ROTATING A (for profiles 137 Classic, 195 Max)	AL-SMART CLIP ROTATING B (for profile 140 Infinit)
Material	plastic	spring steel	stainless steel	stainless steel

COUPLING AND ANGLES

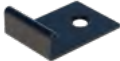

				
Product	AL-SMART joist coupling 25	AL-SMART joist coupling 40	AL-SMART sjoist coupling 75	AL-SMART coupling angle
Material	aluminium	aluminium / stainless steel	aluminium / stainless steel	aluminium / stainless steel

AL-SMART ADDITIONAL ACCESSORIES

				
Product	AL-SMART NUT FOR BOTH SIDED CLIP 140 Infinit (1/2)	AL-SMART SCREW FOR BOTH SIDED CLIP 140 Infinit (2/2)	CLICK CLIP START A4 7 mm	CLIP START A2 - black
Material	stainless steel	stainless steel	stainless steel	stainless steel

DECKING ACCESSORIES

JOISTS





			
Product	joist	joist	AL-BLACK joist
Dimensions	50 × 30 mm	50 × 50 mm	35 × 50 mm
Length	4 m	4 m / 3 m	4 m
Material	WPC	WPC	aluminium
Underlying	150 mm	300 mm	800 mm

COUPLING

	
Product	AL-BLACK joist coupling 50
Material	aluminium

CLIPS





FOR PROFILES 137 CLASSIC AND 195 MAX

	Product	Material
	STANDARD CLIP A4	stainless steel
	START CLIP A4	stainless steel
	CLICK CLIP START A4 7 mm	stainless steel
	START CLIP A2 - black	stainless steel
	STANDARD CLIP - black	stainless steel

FOR PROFILE 140 INFINIT

	Product	Material
	DOUBLESIDED CLIP A2 / A4 3 mm	stainless steel
	DOUBLESIDED CLIP A4 5 mm	stainless steel
	START CLIP A4	stainless steel
	START CLIP A2 - black	stainless steel
	AL-BLACK STANDARD CLIP UNI	plastic
	AL-BLACK STANDARD CLIP PRO	plastic
	AL-BLACK FIXATION POINT A2	stainless steel

SCREWS

					
Product	stainless steel screw A4 for finishing board 4,0 × 60 mm	stainless steel screw A4 3,5 × 25 mm (for clip for WPC joist)	stainless steel screw A4 3,5 × 35 mm (for clip for WPC joist)	stainless steel screw A2 TEX 3,9 × 16 mm	stainless steel screw A2 TEX 3,9 × 25 mm
Material	stainless steel	stainless steel	stainless steel	stainless steel	stainless steel

FINISHING BOARDS

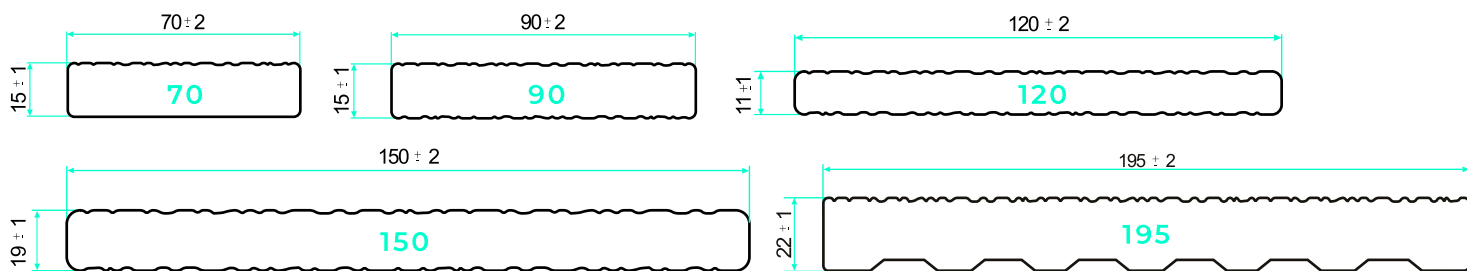

profile	dimensions	texture	length	weight
Finishing board 70	70 × 16 mm	FOREST / SMOOTH	2 m	1,4 kg/lm
Finishing board 90	90 × 16 mm	FOREST / SMOOTH *	2 m	1,7 kg/lm
Finishing board 90	90 × 16 mm	FOREST / RUSTIC NEW	2 m	1,7 kg/lm
Finishing board 120	120 × 11 mm	FOREST / RUSTIC *	3 m	1,7 kg/lm
Finishing board 120	120 × 11 mm	FOREST / NATUR NEW	3 m	1,7 kg/lm
Finishing board 150	150 × 19 mm	FOREST / RUSTIC	4 m	3,4 kg/lm
Finishing board 195	195 × 22 mm	FOREST	4 m	4,7 kg/lm



* Sale of stock 2025