

PRODUCT PORTFOLIO 2025  
DECKING / FENCES / FACADES

## Discover the quality of composite wood TERAFEST



TERAFEST decking are made of composite wood, which combines natural wood with durable HDPE polymer. Thanks to a unique formula and innovative manufacturing process, they stand out for exceptional resistance to all weather conditions – rain, snow, frost, UV radiation, and even chlorinated or salty water. One of the major advantages of TERAFEST composite wood is its minimal maintenance requirements – simply give it a thorough cleaning once a year, and your decking will look as good as new. Instead of worrying about maintenance, you can fully enjoy moments spent with family and friends. With complete control over our production process and confidence in the quality of our decking, we offer a warranty of up to 25 years.

European manufacturer of composite materials.



## COLOR MATURATION

During the first weeks or months after installation, depending on the intensity of sunlight, rainfall and the season, there is a maturation of colour in the surface of the deck boards. It is the leaching of lignin from the wood component in TERAFEST® material, which is a blend of wood (60%) and HDPE (40%). Lignin is a natural part of any type of wood. Due to leaching of tannin, which is caused by water and sunlight, in the first weeks or months, boards temporarily change their colour shade, usually to a yellowy tinge. This process over time, with exposure to sunlight and rain, will return to the original shade.

	 	 <b>INSTALLATION</b>	 <b>1 MONTH</b>	 <b>18 MONTHS</b>	 <b>25 YEARS</b>
TEAK					
PALISANDER					
INOX					
EBEN					

## AND I BRING MORE JOY TO YOUR LIFE

Do you dream of a beautiful, luxurious terrace that requires minimal maintenance? Do you love elegance of wood but want to avoid painting or treating it? Would you simply like to enjoy quality time with family and friends on a stunning terrace? I'm here for you.



### I AM EASY TO MAINTAIN AND SAVE YOUR TIME

Just wash me once a year with a power-washer once a year. Thanks to my composition, I am resistant to all weather conditions, chlorinated and salty water, wood-destroying fungi, rot, and insects.



### THEY WILL MAKE ME EXACTLY ACCORDING TO YOUR NEEDS

Choose me in the color, width and length which suits you. I stand out with unique surfaces and an exceptionally wide selection of colors and profiles.



### I AM SAFE

I am not slippery and I do not form splinters. I am completely safe for walking barefoot. I am also perfect for pools and hot tubs.



### I WILL BE INSTALLED BY PROFESSIONALS

I only work with certified and reliable installers.



### MY VALUE IN TIME

You get me with a guarantee of up to 25 years. However, laboratory tests estimate the lifespan of the decking to be several decades.





### I LOVE NATURE

I do not contain any toxic substances, I am eco-friendly, and 100% recyclable.



**FOREST**  
BASIC COLOURS  
embossed texture

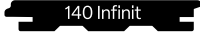

profile	dimensions	stock length	custom length	weight
 137 Classic	137 × 22 mm	4 m	2–6 m	3,3 kg/lm
 195 Max	195 × 22 mm	4 m	2–4 m	4,7 kg/lm
 140 Infnit	140 × 22 mm	–	2–6 m	3,4 kg/lm



**NATUR**  
BASIC COLOURS  
embossed wood texture





profile	dimensions	stock length	custom length	weight
 137 Classic	137 × 22 mm	4 m	2–6 m	3,3 kg/lm

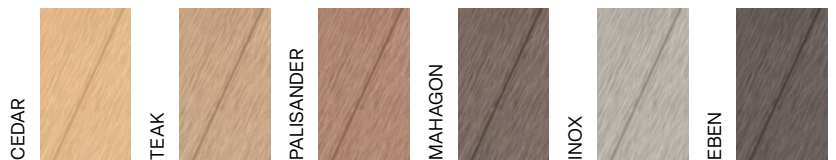

**RUSTIC**  
BASIC COLOURS  
embossed rustic texture



profile	dimensions	stock length	custom length	weight
 137 Classic	137 × 22 mm	4 m	2–6 m	3,3 kg/lm
 195 Max	195 × 22 mm	–	2–4 m	4,7 kg/lm
 140 Infnit	140 × 22 mm	–	2–6 m	3,4 kg/lm



**SMOOTH**  
BASIC COLOURS  
smooth texture



profile	dimensions	stock length	custom length	weight
 137 Classic	137 × 23 mm	–	2–6 m	3,4 kg/lm



**GROOVE**  
BASIC COLOURS  
grooved texture



profile	dimensions	stock length	custom length	weight
 137 Classic	137 × 23 mm	4 m	2–6 m	3,4 kg/lm



**FOREST**  
PLUS COLOURS  
embossed texture

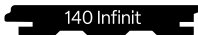

profile	dimensions	stock length	custom length	weight
 137 Classic	137 × 22 mm	4 m	2–6 m	3,3 kg/lm
 140 Infnit	140 × 22 mm	–	2–6 m	3,4 kg/lm



**NATUR**  
PLUS COLOURS  
embossed wood texture



profile	dimensions	stock length	custom length	weight
 137 Classic	137 × 22 mm	4 m	2–6 m	3,3 kg/lm



**RUSTIC**  
PLUS COLOURS  
embossed rustic texture

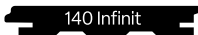

profile	dimensions	stock length	custom length	weight
 137 Classic	137 × 22 mm	4 m	2–6 m	3,3 kg/lm
 140 Infnit	140 × 22 mm	–	2–6 m	3,4 kg/lm



**SMOOTH**  
PLUS COLOURS  
smooth texture



profile	dimensions	stock length	custom length	weight
 137 Classic	137 × 23 mm	–	2–6 m	3,4 kg/lm

ECOLINE





**ECOLINE NATUR**  
BASIC COLOURS  
100% recycled wood-textured surface

**NEW**



profile	dimensions	stock length	custom length	weight
 136 Ecoline Classic	136 × 22 mm	4 m	2–6 m	3,3 kg/lm





## JOISTS

			
<b>Product</b>	AL-SMART joist 25	AL-SMART joist 40	AL-SMART joist 75
<b>Dimensions</b>	35 × 25 mm	40 × 40 mm	40 × 75 mm
<b>Length</b>	4 m	4 m	4 m
<b>Material</b>	aluminium	aluminium	aluminium
<b>Underlying</b>	400 mm	600 mm	1000 mm





## CLIPS

				
<b>Product</b>	AL-SMART STANDARD CLIP	AL-SMART START CLIP 7 mm	AL-SMART CLIP ROTATING A (for profiles 137 Classic, 195 Max)	AL-SMART CLIP ROTATING B (for profile 140 Infnit)
<b>Material</b>	plastic	spring steel	stainless steel	stainless steel

## COUPLING AND ANGLES

				
<b>Product</b>	AL-SMART joist coupling 25	AL-SMART joist coupling 40	AL-SMART joist coupling 75	AL-SMART coupling angle
<b>Material</b>	aluminium	aluminium / stainless steel	aluminium / stainless steel	aluminium / stainless steel

## AL-SMART ADDITIONAL ACCESSORIES

				
<b>Product</b>	AL-SMART NUT FOR BOTH SIDED CLIP 140 Infnit (1/2)	AL-SMART SCREW FOR BOTH SIDED CLIP 140 Infnit (2/2)	CLICK CLIP START A4 7 mm	CLIP START A2 – black
<b>Material</b>	stainless steel	stainless steel	stainless steel	stainless steel

## INSTALLATION OF JOISTS



### max. unsupported part of the joist

WPC JOIST 50 × 30	15 cm
WPC JOIST 50 × 50	30 cm
AL-SMART JOIST 25 × 35	40 cm
AL-SMART JOIST 40 × 40	60 cm
AL-BLACK JOIST 35 × 50	80 cm
AL-SMART JOIST 75 × 40	100 cm

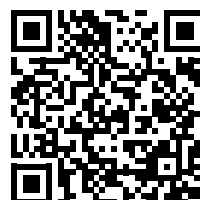

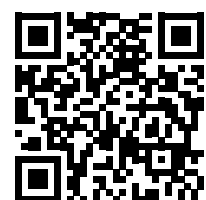

INSTALLATION VIDEO  
<https://youtu.be/SlgX3mgcgSI>



ASSEMBLY INSTRUCTIONS  
<https://www.terafest.eu/downloads/>

## JOISTS





			
<b>Product</b>	joist	joist	AL-BLACK joist
<b>Dimensions</b>	50 × 30 mm	50 × 50 mm	35 × 50 mm
<b>Length</b>	4 m	4 m / 3 m	4 m
<b>Material</b>	WPC	WPC	aluminium
<b>Underlying</b>	150 mm	300 mm	800 mm

## COUPLING

	
<b>Product</b>	AL-BLACK joist coupling 50
<b>Material</b>	aluminium

## CLIPS





### FOR PROFILES 137 CLASSIC AND 195 MAX

	Product	Material
	STANDARD CLIP A4	stainless steel
	START CLIP A4	stainless steel
	CLICK CLIP START A4 7 mm	stainless steel
	START CLIP A2 - black	stainless steel
	STANDARD CLIP - black	stainless steel

### FOR PROFILE 140 INFINIT

	Product	Material
	DOUBLESIDED CLIP A2 / A4 3 mm	stainless steel
	DOUBLESIDED CLIP A4 5 mm	stainless steel
	START CLIP A4	stainless steel
	START CLIP A2 - black	stainless steel
	AL-BLACK STANDARD CLIP UNI	plastic
	AL-BLACK STANDARD CLIP PRO	plastic
	AL-BLACK FIXATION POINT A2	stainless steel



## SCREWS

					
<b>Product</b>	stainless steel screw A4 for finishing board 4,0 × 60 mm	stainless steel screw A4 3,5 × 25 mm (for clip for WPC joist)	stainless steel screw A4 3,5 × 35 mm (for clip for WPC joist)	stainless steel screw A2 TEX 3,9 × 16 mm	stainless steel screw A2 TEX 3,9 × 25 mm
<b>Material</b>	stainless steel	stainless steel	stainless steel	stainless steel	stainless steel



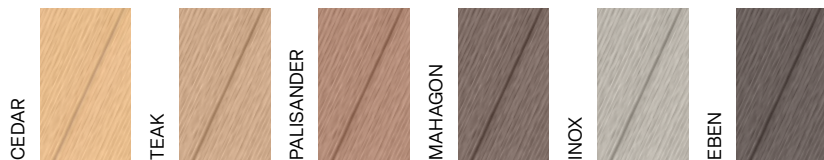

**FENCES**  
BASIC COLOURS



profile	dimensions	texture	stock length	custom length	weight
	90 × 15 mm	forest/forest	–	1,0 – 3,6 m	1,65 kg/lm
	120 × 11 mm	forest/forest	–	1,0 – 3,6 m	1,65 kg/lm
	120 × 11 mm	natur/forest <span style="background-color: #90EE90; padding: 2px;">NEW</span>	–	1,0 – 3,6 m	1,65 kg/lm

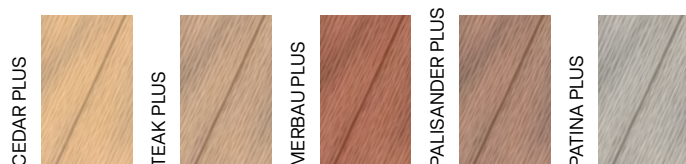





**FENCES**  
PLUS COLOURS

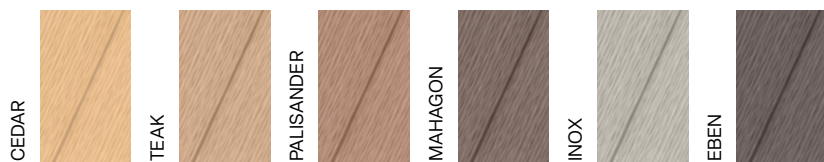

profile	dimensions	texture	stock length	custom length	weight
	120 × 11 mm	forest/forest	3,6 m	1,0 – 3,6 m	1,65 kg/lm
	120 × 11 mm	natur/forest <span style="background-color: #90EE90; padding: 2px;">NEW</span>	–	1,0 – 3,6 m	1,65 kg/lm

**FINISHING BOARDS**  
BASIC COLOURS



profile	dimensions	texture	length	weight
	board 70 70 × 16 mm	forest/smooth	2 m	1,35 kg/lm
	board 90 90 × 16 mm	forest/rustic <span style="background-color: #90EE90; padding: 2px;">NEW</span>	2 m	1,7 kg/lm
	board 90 90 × 16 mm	forest/smooth*	2 m	1,7 kg/lm
	board 120 120 × 11 mm	natur/forest <span style="background-color: #90EE90; padding: 2px;">NEW</span>	3 m	1,65 kg/lm
	board 120 120 × 11 mm	forest/rustic*	3 m	1,65 kg/lm
	board 150 150 × 19 mm	forest/rustic	4 m	3,4 kg/lm
	board 195 195 × 22 mm	forest	4 m	4,7 kg/lm

\* Sale of stock 2025





# TERAFEST® DECKING

EMBELLISH THOUSANDS OF GARDENS  
IN THE CZECH REPUBLIC AND ABROAD



## TERAFEST FACADE PROFILES

We present you new portfolio of facade profiles, which we have developed based on the increasing demand for durable and unconventional facade solutions.

Outdoor facade profiles are an original choice for cladding exterior walls, supporting elements, columns, portals and gables. Due to their high durability, stability and minimal need for maintenance, they are a long-term solution for cladding walls around decking, garden walls, pergolas and parking shelters. You can choose from a wide range of colors that can be stylishly matched to the decking and fence. They perfectly imitate wood itself, but eliminate its shortcomings. Wood-composite cladding has high resistance to weather effects (sun, rain, frost, snow), long-term stable shape and requires almost no maintenance. In addition, they have the same benefit as decking, i.e. a 25-year guarantee against wood-destroying fungi, rot and insects. You can also rely on the fact that this is a purely European product.

### 45 MINISTAR SMOOTH BASIC COLOURS

NEW

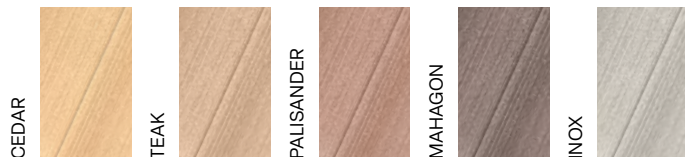

profile	dimensions	stock length	custom length	weight
brushed/unbrushed	45 × 23 mm	–	2 – 4 m	1,25 kg/lm
brushed/unbrushed with groove	45 × 23 mm	–	2 – 4 m	1,15 kg/lm

### 45 MINISTAR RUSTIC BASIC COLOURS

NEW

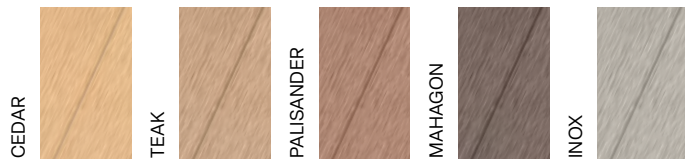

profile	dimensions	stock length	custom length	weight
	45 × 22 mm	–	2 – 4 m	1,25 kg/lm
with groove	45 × 22 mm	–	2 – 4 m	1,15 kg/lm

### 90 STAR SMOOTH BASIC COLOURS

NEW

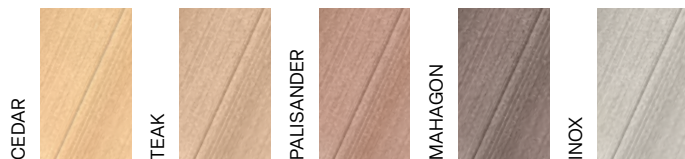
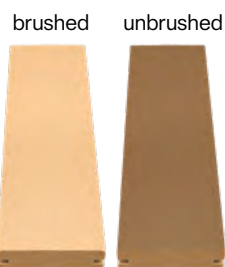

profile	dimensions	stock length	custom length	weight
brushed/unbrushed	90 × 23 mm	–	2 – 4 m	2,5 kg/lm
brushed/unbrushed with groove	90 × 23 mm	–	2 – 4 m	2,4 kg/lm

### 90 STAR RUSTIC BASIC COLOURS

NEW

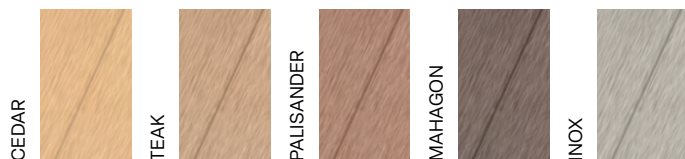

profile	dimensions	stock length	custom length	weight
	90 × 22 mm	–	2 – 4 m	2,5 kg/lm
with groove	90 × 22 mm	–	2 – 4 m	2,4 kg/lm

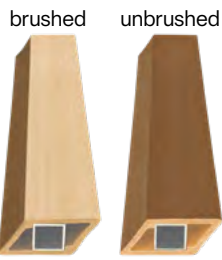

**90 RHOMBA SMOOTH**  
BASIC COLOURS

NEW



profile	dimensions	stock length	custom length	weight
 brushed/unbrushed	90(70) × 41 mm	-	1 – 3 m	1,9 kg/lm



**90 RHOMBA RUSTIC**  
BASIC COLOURS

NEW





profile	dimensions	stock length	custom length	weight
	90(70) × 41 mm	-	1 – 3 m	1,9 kg/lm

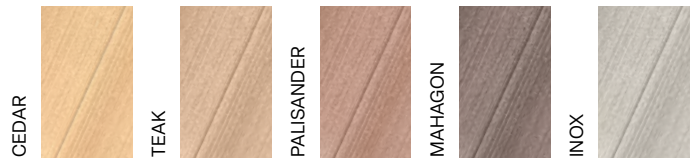

**50 BONE SMOOTH**  
**50 MINIBONE SMOOTH**  
BASIC COLOURS

NEW



profile	dimensions	stock length	custom length	weight
 brushed/unbrushed	50 × 50 mm	-	2 – 4 m	2,3 kg/lm
 brushed/unbrushed	50 × 30 mm	-	2 – 4 m	1,4 kg/lm





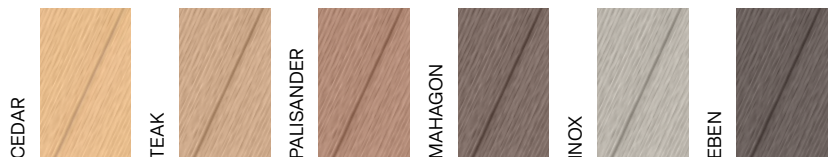

**150 PANEL FOREST**  
BASIC COLOURS  
embossed texture



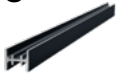



profile	dimensions	stock length	custom length	weight
	150 × 14 mm	3,3 m	2 - 4 m	2,1 kg/lm

**JOIST AND BOLTS**

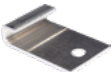
			
<b>Product</b> FASADO - facade joist 17 × 15 × 360 mm	FASADO bolt 4,2 × 28 mm TEX	FASADO bolt 4,8 × 47 mm TEX Black	FASADO bolt 4,8 × 34 mm TEX Black
<b>Material</b> aluminium	stainless steel	stainless steel	stainless steel

**CLIPS**

				
<b>Product</b> Standard clip for 150 Panel	Start clip for 150 Panel	Start clip click for 150 Panel	Fasade clip Standard 6 mm	Fasade clip Standard 13 mm
<b>Material</b> stainless steel	stainless steel	stainless steel	plastic	plastic



Your certified installer:

